



Mess-, Regel- und
Überwachungsgeräte
für Haustechnik,
Industrie und Umweltschutz

Lindenstraße 20
74363 Güglingen
Telefon +49 7135 102-0
Service +49 7135 102-211
Telefax +49 7135 102-147
info@afriso.de
www.afriso.com

Operating instructions

Bourdon tube pressure gauges

Capsule pressure gauges

Diaphragm pressure gauges

Spring diaphragm pressure gauge for differential pressure

D0, D1, D2, D3, D4, D5, D6, D7, D8, D9

Nominal size: 40, 50, 63, 80, 100, 160, 250



-  Read instructions before using product!
-  Observe all safety information!
-  Keep instructions for future use!

Table of contents

1	This instruction manual.....	4
1.1	Precautions	4
2	Safety.....	5
2.1	Intended use.....	5
2.2	Predictable incorrect application	6
2.3	Safe handling	7
2.4	Staff qualification	7
2.5	Modifications to the product	7
2.6	Usage of spare parts and accessories.....	8
2.7	Liability information	8
3	Product description.....	9
3.1	Measuring principle Bourdon tube pressure gauge	9
3.2	Measuring principle capsule type pressure gauge.....	10
3.3	Measuring principle diaphragm pressure gauge.....	10
3.4	Measuring principle spring diaphragm pressure gauge (differential pressure)	10
4	Selection criteria	10
4.1	Range.....	10
4.2	Properties of the media	11
4.3	Ambient conditions	12
4.4	Overload	12
4.5	Accuracy classes	13
4.6	Connection	14
4.7	Nominal sizes.....	14
4.8	Cleanliness.....	14
5	Technical specifications.....	15
5.1	Approvals, tests and conformities	20
6	Transport and storage	21
7	Mounting and commissioning.....	21
7.1	Connection thread	24
7.2	Measurement arrangements	25
7.3	Mounting position	26
7.4	Connection types	27
7.5	Mounting types.....	28
7.6	Pressure tap piece	29
7.7	Measuring line	29
7.8	Commissioning the product.....	30
8	Operation.....	32

8.1	Dismounting the pressure gauge	32
9	Additional equipment	33
9.1	Shut-off unit	33
9.2	Pressure gauge holder	33
9.3	Siphons	34
9.4	Chemical seals	34
9.5	Overpressure safety devices.....	34
9.6	Pressure gauge with maximum pointer.....	35
9.7	Electrical contacts	35
10	Type code – design numbers	38
11	Maintenance	39
12	Decommissioning, disposal	40
13	Returning the device.....	41
14	Spare parts and accessories	41
15	Warranty	41
16	Copyright	41
17	Customer satisfaction	42
18	Addresses	42
19	Appendix.....	43
19.1	EU Declaration of Conformity.....	43
19.2	Information on the Pressure Equipment Directive	44



1 This instruction manual

This instruction manual is part of the product.

- ▶ Read this manual before using the product.
- ▶ Keep this manual during the entire service life of the product and always have it readily available for reference.
- ▶ Always hand this manual over to future owners or users of the product.

1.1 Precautions

WARNING WORD



Type and source of the hazard are shown here.

- ▶ Precautions to take in order to avoid the hazard are shown here.

Warning word	Meaning
WARNING	Possibly imminent danger! Failure to observe the information may result in death or severe injuries.
CAUTION	Dangerous situation! Failure to observe the information may result in minor or severe injuries as well as damage to property.



2 Safety

2.1 Intended use

Bourdon tube pressure gauges

Bourdon tube pressure gauges may only be used to display the pressure of media which are not highly viscous and which do not crystallize.

Bourdon tube pressure gauges NS50 with inductive contact (RF50ExIK1.2/ RF50IK1.2 - D302/D312) are additionally suitable for the generation of signals within the given adjustment range. These bourdon tube pressure gauges must always be operated in conjunction with a suitable isolating switching amplifier (for example, Turck, MK13-P-EX0/24V).

Bourdon tube pressure gauges with clamp chemical seal (Tri-Clamp, ISO 2852: RF63Ch-D9xx/RF100E-D9xx with MD60 1½"/MD60 2") are additionally suitable for highly viscous, perishable and hot media. These Bourdon tube pressure gauges are particularly suitable for use in the food and beverages industry, for example, for milk and dairy products.

Capsule pressure gauges

Capsule type pressure gauges may only be used to display the pressure of dry, gaseous media.

Diaphragm pressure gauges

Diaphragm pressure gauges may only be used to display the pressure of high-viscosity or crystallising media.

Spring diaphragm pressure gauge

Spring-diaphragm pressure gauges may only be used for differential pressure measurement with low differential pressure and high static pressure for gaseous and liquid media which are not highly viscous and not corrosive. Particularly suitable for monitoring filters, pumps and pipe systems.



Media

The fluids used must be compatible with the materials of the product under the specific measuring conditions (for example, temperature, atmosphere, immunity of the material against the measured fluid, etc.) and which do not cause chemical reactions.

- Intended operation as per EN 837-1/-3
- No hot media with temperatures of more than 70 °C in the pressure gauge. Take into account the compression heat that is generated in the case of rapid pressure changes of gases.
- The pressure gauge is neither subjected to pressure surges nor to pressure fluctuations.

Pressure gauges with switching contacts may only be used in certified intrinsically safe circuits as per EN 60079-11.

Any use other than the application explicitly permitted in this instruction manual is not permitted.

2.2 Predictable incorrect application

The pressure gauges must never be used in the following cases:

- Measurement of pressure exceeding the full scale value of the pressure gauge
- Operation outside of the specified temperature range
- Use as a part of a safety system to protect against exceeding permissible limit values (equipment parts with a safety-related function)
- If used in hazardous areas / Ex zones: operation outside of the specified intrinsically safe limit values

2.3 Safe handling

WARNING



Injury due to escaping fluids or bursting parts as a result of leaks or bursting of pressurised parts

- ▶ Use Bourdon tube safety pressure gauges with blow-out (for example, blow-out back).

As per EN 837, liquid-filled pressure gauges must have a blow-out device (version S1, S2 or S3).

Pressure gauges for oxygen and acetylene must be safety pressure gauges (version S2 or S3 as per EN 837-1 or pressure gauge as per ISO 5171). All wetted parts must comply with EN 29539 must be free from oil and grease. Only lubricants suitable for oxygen at maximum operating pressure may be used. The pressure gauges must never be exposed to humidity.

Pressure gauges with glycerine filling must not be used for oxygen or other oxidising process fluids. High-concentration fluorine liquids and chlorinated liquids (for example, halocarbon) are suitable for such applications.

You must observe all pertinent directives and guidelines in the case of refrigerating systems, compressors, etc. as well as hazardous substances such as

- Oxygen
- Acetylene
- Flammable substances
- Explosive substances
- Toxic substances
- ▶ After an external fire, measured fluid can escape, in particular at soft solder connections. Verify and, if necessary, replace all products before re-commissioning the system.

2.4 Staff qualification

The product may only be mounted, commissioned, operated, maintained, decommissioned and disposed of by qualified, specially trained staff.

Electrical work may only be performed by trained electricians and in compliance with all applicable local and national directives.

2.5 Modifications to the product

Changes or modifications made to the product by unauthorised persons may lead to malfunctions and are prohibited for safety reasons.



2.6 Usage of spare parts and accessories

Usage of unsuitable spare parts and accessories may cause damage to the product.

- ▶ Use only genuine spare parts and accessories of the manufacturer.

2.7 Liability information

The manufacturer shall not be liable in any form whatsoever for direct or consequential damage resulting from failure to observe the technical instructions, guidelines and recommendations.

The manufacturer or the sales company shall not be liable for costs or damages incurred by the user or by third parties in the usage or application of this product, in particular in case of improper use of the product, misuse or malfunction of the connection, malfunction of the product or of connected products. The manufacturer or the sales company shall not be liable for damage whatsoever resulting from any use other than the use explicitly permitted in this instruction manual.

The manufacturer shall not be liable for misprints.

3 Product description

3.1 Measuring principle Bourdon tube pressure gauge

Bourdon tube pressure gauges contain measuring elements (Bourdon tubes) which are deformed if pressure is applied. This motion is transmitted to a movement.

Bourdon tubes are tubes with a oval cross-section, bent into a circle. The pressure to be measured acts on the inside of the tube so that the oval cross-section approximates a circular shape. The bending of the Bourdon tube causes ring tension which bends the tube open. The loose tube end performs a movement which is a measure of the pressure.

Circular tubes with an angle of 270° are typically used for pressures of up to 60 bar; for greater pressures, the tubes with several helical windings are used.

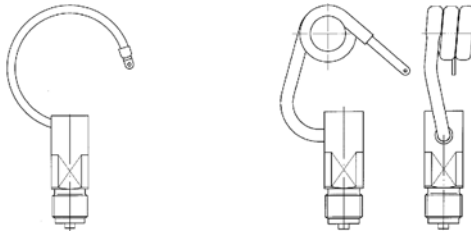

Fig. 1: Circular tube Fig. 2: Helical tube

The Bourdon tubes usually consist of copper alloys or alloyed steel. Because of their sturdiness and the easy handling, the Bourdon tube pressure gauge is the most commonly used pressure gauge in technical pressure measurement.

Bourdon tube pressure gauge NS50 with inductive contact

The inductive contacts used in RF50 Ex IK1.2/RF50 IK1.2 pressure gauges are non-contacting electric displacement pick-ups (proximity switches) as per EN 50227 / NAMUR. The output signal is determined by the presence or the absence of a control flag in the electromagnetic field of the proximity switch. The electromagnetic field is concentrated between two opposing coils. The switch is activated when the control flag moved by the gauge pointer reaches the air gap between the two coils. The signal is generated without a delay, according to the motion of the gauge pointer.

If the control flag is outside of the air gap between the two coils, the system is low-resistance (approx. 1000 Ohm), the current input is then > 3 mA. If the control flag is in the air gap between the two coils, the system is high-resistance (approx. 7000 Ohm), the current input is then < 1 mA.



The difference in the current input is used to control a switching amplifier. This amplifier converts the input signal into a binary output signal. Therefore, the switching function of an inductive contact is not only determined by the inductive contact itself, but also by the switching amplifier.

3.2 Measuring principle capsule type pressure gauge

Capsule membranes consist of circular corrugated diaphragms sealed into a single unit. Pressure is applied in the centre and acts on the inside of the diaphragms. The resulting deformation is proportional to the pressure.

3.3 Measuring principle diaphragm pressure gauge

Diaphragm pressure gauges use circular corrugated diaphragms. The pressure to be measured is applied at one side. The deflection of the diaphragm is proportional to the pressure.

3.4 Measuring principle spring diaphragm pressure gauge (differential pressure)

The pressures act on two pressure chambers separated by an elastic diaphragm. If there are different pressures in the chambers, the diaphragm is axially displaced against a compression spring. This is transmitted to the movement by means of a rod. The differential pressure is directly indicated by a pointer. The diaphragm is held by a metallic support which results in an overpressure safety of up to 25 bar at both sides.

4 Selection criteria

WARNING



Injury and damage to the pressure gauge due to unsuitable pressure gauges

- ▶ Only use pressure gauges or safety pressure gauges which are suitable for the actual operating conditions (measuring range, ambient conditions, materials, over-pressure safety ...).
- ▶ Verify compliance with all applicable directives, guidelines and safety requirements as well as the selection criteria (safety aspects) as per EN 837-2 in your specific application.

4.1 Range

- ▶ Select the range in such a way that the maximum pressure load does not exceed 75 % of the full scale value in the case of static load and 65 % of the full scale value in the case of dynamic

load. This prolongs the service life of the pressure gauge (see EN 837-2).

4.2 Properties of the media

Pressure surges

Pressure surges must not exceed the application range of the pressure gauges. The measuring element must not be subjected to pressure surges or sudden pressure changes. Such changes considerably reduce the service life of the pressure gauge. For example, such changes occur if the pressure gauge is mounted to a pump, as indicated by major oscillations of the pointer.

- ▶ Reduce such pressure surges by installing a damper or an overload protection device between the pressure source and the elastic measuring element.

Throttle elements considerably reduce the inlet cross section which leads to a delay of the pressure change in the measuring element. The susceptibility to dirt is a disadvantage of such arrangements.

Damping elements at the movement delay the pointer motion and cause increased wear of the movement.

Liquid filling cause a damping of the measuring element and decreases the wear of the moving parts.

Excessively high temperatures of the fluid in the case of Bourdon tube pressure gauges

- ▶ Install a siphon (see chapter 9.3, page 34) or a chemical seal (see chapter 9.4, page 34) to help protect the pressure gauge from the hot fluid.

In the case of capsule type pressure gauges and spring diaphragm pressure gauges, the temperature of the fluid must not exceed the permissible operating temperature.

Corrosive media

Standard pressure gauges may be used if corrosive media can be kept away from the measuring device by means of separating elements. If this is impossible, the material most suitable for the fluid to be measured and its pressure must be selected.

1. Provide the manufacturer with all information on the materials that are compatible with the fluid to be measured under the specific measuring conditions.
2. Due to the limited selection of materials for the elastic measuring elements, it may be necessary to use suitable diaphragm pressure gauges or to install chemical seals made of resistant materials (see chapter 9.4, page 34).



4.3 Ambient conditions

Mechanical shocks

Pressure gauges must not be subjected to mechanical shocks.

- ▶ If the installation point is subject to mechanical shocks, install the pressure gauge in a separate location and connect it by means of flexible lines.

Vibrations

Vibrations are indicated by ongoing and frequently unsteady vibrations at the tip of the pointer.

- The installation site of the pressure gauge is subjected to mechanical vibrations.
- ▶ Install a liquid filled pressure gauge.
- ▶ In the case of heavy or unsteady vibrations at the installation point, install the pressure gauge in a separate location and connect it by means of flexible lines.

Ambient temperature

The error limit indicated on the dial applies to an ambient temperature of +20 °C. Different temperatures have an influence on the accuracy; the influence depends on the measuring system.

According to EN 837-1, a deviation of the indication caused by temperature influences is permissible up to the following value with reference to the full scale value:

- Bourdon tube pressure gauges: 0.04 %/K
- Capsule pressure gauges: 0.06 %/K
- Diaphragm pressure gauges: 0.08 %/K
- Spring diaphragm pressure gauges: 0.05 %/K
- ▶ Protect the pressure gauge from atmospheric influences in outdoor applications in order to avoid icing up of the gauge at temperatures below 0 °C.

The viscosity of the filling liquid in pressure gauges with liquid filling increases at decreasing temperatures. This causes a considerable delay in indication.

Corrosive atmosphere

- ▶ In the case of a corrosive atmosphere, use suitable housings and assemblies made of resistant materials, for example, special surface treatments against external influences.

4.4 Overload

Overloads cause tension in the elastic measuring element which decreases its service life and deteriorates the measuring accuracy.

1. Use a pressure gauge whose full scale value is greater than the maximum static pressure.
 - ↳ The pressure gauge is less sensitive to overload and load changes (see also see chapter 4.1, page 10).
2. If, for operational reasons, the range must be smaller than the maximum operating pressure, install an overpressure safety device, see chapter 9.5, page 34.

Spring-diaphragm pressure gauges may be used up to a maximum static pressure of 25 bar.

- ▶ Use a pressure gauge whose full scale value is greater than the maximum differential pressure.

4.5 Accuracy classes

The accuracy class is the error limit in percent of the measuring range. The error limit applies to both positive and negative deviations, based on the measured value.

EN 837-1, chapter 6 specifies the error limits of Bourdon tube pressure gauge, EN 837-3, chapter 6 specifies the error limits of capsule pressure gauges and diaphragm pressure gauges.

Classes 0.1 to 0.6 pressure gauges are primarily used for precision measurements in laboratories and workshops. Classes 1.0 and 1.6 pressure gauges measure the pressure at machines and production facilities. Classes 2.5 and 4 pressure gauges are used for monitoring purposes without special accuracy requirements.

- ▶ When selecting the accuracy class, take into account the assignment of the classes to the nominal sizes (EN 837-1/-3, chapter 6, table 1).



4.6 Connection

- ▶ Select the size and the type of the connection thread according to EN 837-1/-3, chapter 7.3 and observe the selection table as per EN 837-1, chapter 8 (combinations: pressure, thread, nominal size).

Other connections for special industries and applications must be agreed upon.

4.7 Nominal sizes

The nominal size according to EN 837-1/-3 relates to the housing diameter in mm. The following nominal sizes are standardised: 40, 50, 63, 80, 100, 160 and 250.

4.8 Cleanliness

Certain applications require pressure gauges which must have been cleaned in a special way prior to shipment, for example, free from oil and grease, free from silicone.

1. State cleanliness requirements when ordering.
2. Verify that pressure gauge remains clean during installation.



5 Technical specifications

Table 1: Technical specifications Bourdon tube pressure gauges

Parameter	Value
General specifications	
Measuring ranges	-1/0 bar to -1/15 bar 0/0.6 bar to 0/1600 bar
Temperature performance	Rising temperature approx. +0.4 %/K Falling temperature approx. -0.5 %/K (indication error when the temperature of the measuring system deviates from the normal temperature of 20 °C, with reference to the full scale value)
Operating frequency in hazardous areas (EX areas).	Max. 0.1 Hz
Operating temperature range	
Ambient	-20 °C to +60 °C
Fluid	Max. +60 °C for liquid filled devices and devices with soft-soldered Bourdon tubes Max. +100 °C for non-filled devices with hard-soldered or welded bourdon tube
Storage	-40 °C to +70 °C
Application area with static load	
Up to full scale value Type: D4, D5, D8 Type: D2, D3 Type: D1	In NS 100, NS 160, NS 250 (cl. 1.0 up to ≤ 600 bar) In NS 100 (cl. 1.0) In NS 4½"
Up to ¾ full scale value Type: D1, D6, D7, D9, D0 Type: D2, D3, D4, D8 Type: D2 Type: D4	All nominal sizes In NS 40, NS 50, NS 63, NS 80 In NS 100 (cl. 1,6) In NS 160, NS 250 (cl. 0.6 cl. 0.25 cl. 0.1 and cl. 1.0 > 600 bar)



Table 2: Technical specifications Bourdon tube pressure gauge with clamp type chemical seal

Parameter	Value
General specifications	
Degree of protection	> 25 bar = IP 65 (as per EN 60529) ≤ 25 bar = IP 54 (as per EN 60529)
Ranges	0.6-40 bar
Permissible operating pressure	Max. $\frac{3}{4}$ x full scale value
Overpressure safety	Full scale value
Connection	Clamp as per ISO 2852
Nominal diameter	DN 1", DN 1½", DN 2", DN 2½", DN 3"
Surface roughness	Ra = 0.8 (wetted surfaces)
Accuracy	Cl. 1.6 (as per EN 837-1) at +20 °C; cl. 1.0 on request
Mounting position	Vertical (NL90 ±5° as per DIN 16257)
Materials	
All wetted parts	316 L (1.4404/1.4435)
Pressure gauge connection	1.4571/1.4404
Housing/ crimped bezel	1.4301
Filling plug	PUR
Window	Safety glass/polycarbonate
Housing seal	NBR/PUR
Filling liquid	Paraffin oil or silicone oil, (FDA-compliant)
Operating temperature range	
Ambient	-20 °C to +60 °C
Fluid	+80 °C (when mounted: short-term +140 °C for sterilisation)



Table 3: Technical specifications Bourdon tube pressure gauge NS 50 with inductive contact

Parameter	Value
General specifications	
Nominal operating voltage	Nom. 8.2 V DC
Current input	Active area free > 3 mA Active area covered < 1 mA
Type of output	NAMUR
Degree of protection	IP 32 (as per EN 60529)
Permissible operating pressure	Max. full scale value
Overpressure safety	Short-term 1.15 x
Connection	G $\frac{1}{4}$ B or $\frac{1}{4}$ -18 NPT (as per EN 837-1)
Width across flats, spanner	SW 14
Accuracy	Cl. 1,6 (as per EN 837-1) at +20 °C
Switching accuracy	± 2.5 % of full scale value
Mounting position	Vertical (NL90 $\pm 5^\circ$ as per DIN 16257)
Connection cable RF50 Ex IK1.2 RF50 IK1.2	2 m, LiYY blue 2 x 0.14 mm ² 2 m, LiYY grey 2 x 0,25 mm ²
Pin assignment Grey cable Blue cable	WH (white)/+ BN (brown) BL (blue)/+ BN (brown)
Materials	
All wetted parts	1.4571/1.4404
Housing	1.4301
Window/rear wall	Polycarbonate
Operating temperature range	
Ambient	-20 °C to +60 °C Attention: Fluid must not freeze.



Parameter	Value
Fluid	Max. +100 °C Attention: Fluid must not freeze.

Table 4: Technical specifications capsule pressure gauges

Parameter	Value
General specifications	
Measuring ranges	-25/0 mbar to -1000/0 mbar 0/25 mbar to 0/1000 mbar
Temperature performance	Rising temperature approx. +0.06 %/K Falling temperature approx. -0.06 %/K (indication error when the temperature of the measuring system deviates from the normal temperature of 20 °C, with reference to the full scale value)
Operating frequency in hazardous areas (EX areas).	Max. 0.1 Hz
Operating temperature range	
Ambient	-20 °C to +60 °C
Fluid	Max. +60 °C for liquid filled devices and devices with soldered diaphragms made of copper alloys Max. +100 °C for non-filled devices with welded stainless steel diaphragm
Storage	-40 °C to +70 °C
Application area with static load	Up to full scale value

*Table 5: Technical specifications diaphragm pressure gauges*

Parameter	Value
General specifications	
Measuring ranges	0/10 mbar to 0/25 mbar
Temperature performance	Rising temperature approx. +0.08 %/K Falling temperature approx. -0.08 %/K (indication error when the temperature of the measuring system deviates from the normal temperature of 20 °C, with reference to the full scale value)
Operating frequency in hazardous areas (EX areas).	Max. 0.1 Hz
Operating temperature range	
Ambient	-20 °C to +60 °C
Fluid	Max. +60 °C for liquid filled devices Max. +100 °C for non-filled devices
Storage	-40 °C to +70 °C
Application area with static load	Up to full scale value



Table 6: Technical specifications spring diaphragm pressure gauges (differential pressure)

Parameter	Value
General specifications	
Measuring ranges	0/250 mbar to 0/6 bar
Temperature performance	Rising temperature approx. +0.05 %/K Falling temperature approx. -0.05 %/K (indication error when the temperature of the measuring system deviates from the normal temperature of 20 °C, with reference to the full scale value)
Operating temperature range	
Ambient	-20 °C to +60 °C
Fluid	Max. +60 °C Attention: Fluid must not freeze.
Storage	-40 °C to +70 °C

See the current AFRISO catalogue or www.afriso.com for additional technical specifications

5.1 Approvals, tests and conformities

Bourdon tube pressure gauges comply with the European standard for pressure measuring instruments EN 837-1, capsule pressure gauges and diaphragm pressure gauge comply with EN 837-3.

Pressure gauges with a full scale value ≥ 500 mbar comply with the Pressure Equipment Directive (2014/68/EU).

Bourdon tube pressure gauges with clamp chemical seal

The pressure gauges also comply with the US standard 3-A Sanitary Standard 74-03.

Bourdon tube pressure gauge NS50 with inductive contact

The pressure gauges also comply with the ATEX directive (2014/34/EU).

6 Transport and storage

CAUTION

Damage to the pressure measuring instrument, reduced accuracy or leaks at the measuring system due to improper transportation

- ▶ Do not throw or drop the product.

CAUTION

Damage to the product due to improper storage.

- ▶ Store the product in a clean and dry environment.
- ▶ Only store the product within the permissible temperature range.

7 Mounting and commissioning

Safety information on mounting

- ▶ For pressure gauge with blow-out device: The blow-out device must not be blocked by parts or by dirt. The distance between the blow-out device and other objects must be at least 20 mm.
- ▶ Never hold the housing of a pressure gauge when mounting or dismantling it.
- ▶ In order to avoid damage to the pressure gauge, always use a suitable spanner to apply the tightening torque to the appropriate areas at the connection piece.
- ▶ When the pressure connection piece of a wall-mounted or panel-mounted pressure gauge is tightened, always hold the connection piece with a suitable spanner in order to help avoid damage to the pressure gauge or its fastening points.



Preparing mounting

The pressure gauge must be mounted in such a way that it is not subjected to shocks and vibrations.

The pressure gauge must be easy to read. Avoid parallax errors when reading the pressure gauge.

In order to obtain a position of the pressure gauge that allows for easy reading, threaded connections should be made by means of a female/female connection or a union nut.

Arrange the pressure gauge in such a way that the operating temperature never exceeds or falls below the permissible values. Account for the influences of possible convection or heat radiation.

A height difference between the pressure tap piece and the pressure gauge causes a shift of the initial value if the fluid in the measuring line does not have the same density as the ambient air.

The shift of the initial value $\Delta p = 10^{-5} (\rho_M - \rho_L) \cdot g \cdot \Delta h$ [bar]

$(\rho_M - \rho_L)$	=	Difference in density	
ρ_M	=	Density of measured fluid	[kg/m ³]
ρ_L	=	Density of air (1.205 at +20 °C)	[kg/m ³]
g	=	Gravitational acceleration (mean value 9.81)	[m/s ²]
Δh	=	Height difference	[m]

The displayed value is reduced by Δp if the pressure gauge is at a higher level than the pressure tap piece, it is increased by Δp if the pressure gauge is at a lower level.

- ▶ If a static liquid column acts on the pressure gauge, verify correct adjustment of the pressure gauge and ensure that the adjustment is shown on the dial.
- ▶ If the pressure gauge is at a lower level than the pressure tap piece, flush the measuring pipe prior to commissioning in order to remove external matter.

It is advisable to install a shut-off unit to facilitate the disassembly of the pressure gauge for maintenance purposes, see chapter 9.1, page 33.

Bourdon tube pressure gauges with measuring ranges of ≤ 25 bar have a pressure relief opening (blow-out) at the top of the housing. These pressure gauges have appropriate warning labels fitted. For liquid filled gauges with lateral connection, special housings are used and the pressure relief opening (blow-out) is located at the top of the housing with the gauge in its installed position.

- ▶ Vent the gauge by cutting off the nipple at the pressure relief opening (blow-out).
- ↙ The internal pressure compensation helps to ensure an accurate indication.

Bourdon tube pressure gauges with clamp chemical seal

- ▶ Do not remove the protective cap of the chemical seal until immediately before installation.
- ▶ Protect the diaphragm from damage during installation.
- ▶ Do not touch the diaphragm with pointed objects.
- ▶ Mount the unit only to a suitable clamp connection piece, with suitable clamp and sealing ring as per ISO 2852.
- ▶ Protect the diaphragm from damage after disassembly; use a suitable protective plastic cap, if possible.

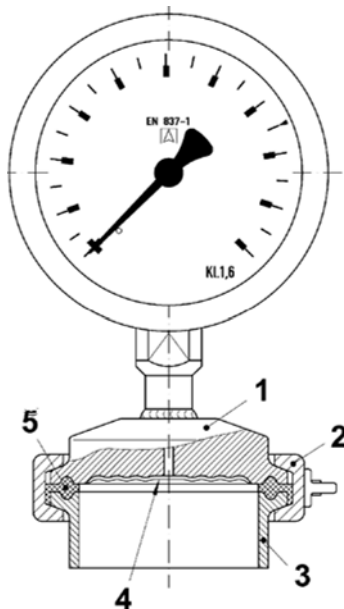

- 1 Pressure gauge with chemical seal
- 2 Clamp
- 3 Clamp connection piece
- 4 Diaphragm
- 5 Sealing ring

Fig. 3: Mounting Bourdon tube pressure gauge with clamp chemical seal

7.1 Connection thread

- ☑ The correct pressure gauge connection was selected.

The pressure connections must be tight. You may only use a suitable seal whose material is compatible with the fluid to seal the connection.

1. Cylindrical threads: Seal the sealing surface with suitable flat gaskets as per EN 837-1, chapter 7.3.6, profile gaskets (see chapter 14, page 41) or lens-shaped rings for the corresponding high-pressure connections.

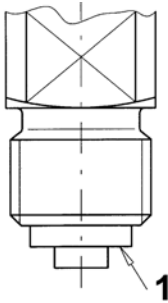

1 Sealing surface

Fig. 4: Cylindrical threads

2. Conical threads: Seal the pressure gauge with sealing material such as PTFE tape, hemp, etc. when screwing the threads together.

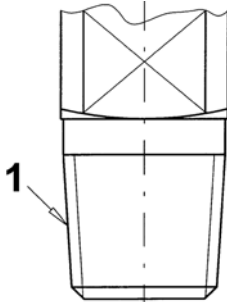

1 Sealing in thread

Fig. 5: Conical threads, for example, pipe thread as per DIN 2999

3. Verify tightness of the threaded connection during the first pressure measurement.

7.2 Measurement arrangements

Table 7: Proven measurement arrangements and suggestions for the components as per VDE/VDI 3512-3

State of fluid	Liquid			Gaseous		
State of filling in measuring line	Liquid	Partially gassing	Completely evaporated	Gaseous	Partially condensed (humid)	Completely condensed
Examples	Condensate	Boiling liquids	"Liquid gases"	Dry air	Humid air, flue gas	Steam
Pressure gauge above pressure tap point	1	2	3	4	5	6
Pressure gauge below pressure tap point	7	8		9	10	11

Numbers 3, 4, 5, 7, 8 and 11 are preferred arrangements.



7.3 Mounting position

The orientation is indicated by the orientation mark on the dial.

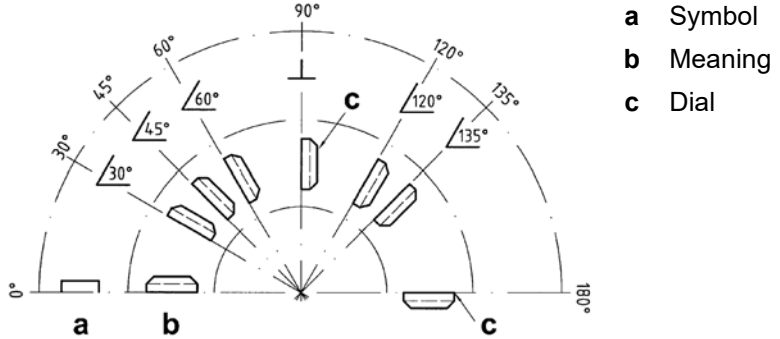

Fig. 6: Orientation mark as per EN 837

If no orientation mark is indicated on the dial, the pressure gauge must be mounted vertically (as per EN 837).

Pressure gauge and chemical seal with 3A approval

The fluid must be able to flow off.

- ▶ Do not mount the pressure gauge and the chemical seal "upside down".
- ▶ Parts welded to the tank must be mounted flush with the inside wall of the tank (1). The surface roughness R_a of the welding seams must not exceed 0.8.

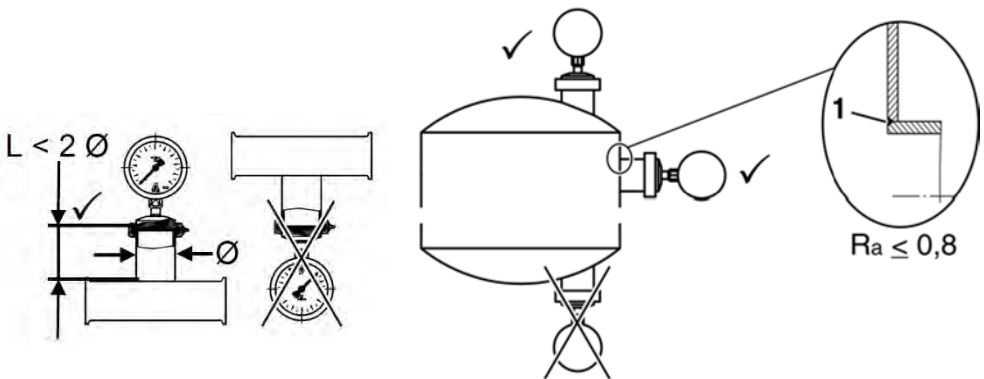

Fig. 7: At T piece

At tank

7.4 Connection types

Possible connection types for pressure connections.

Table 8: Cylindrical thread, sealing with seal at sealing surface

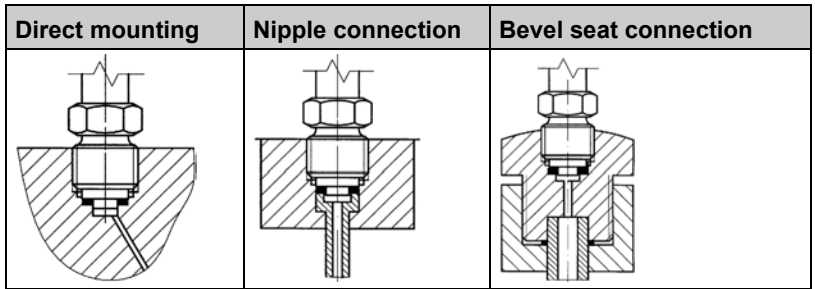
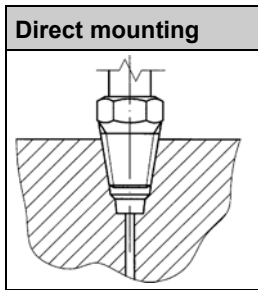

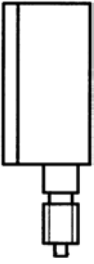
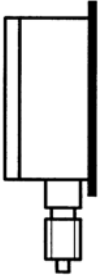

Table 9: Conical threads, sealing in the thread





7.5 Mounting types

Table 10: Mounting type and position of the connection pieces as per EN 837

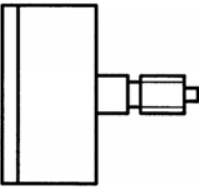
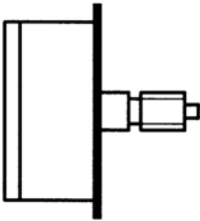
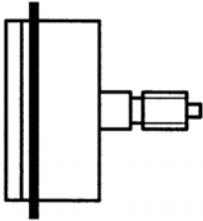
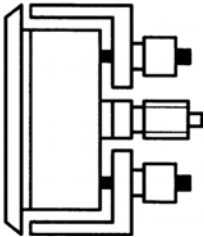
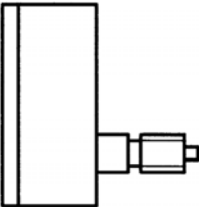
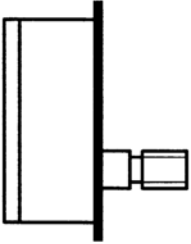
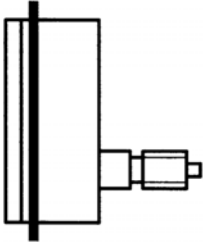
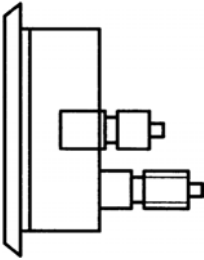
	Direct connection	Wall mounting	Wall mounting	
			3-hole mounting	Clamp fixing
Bottom connection piece	10	11	12	
			 Not recommended	
Rear connection piece, centre	20	21	22	23
		 Not recommended		
Rear connection piece, bottom	30	31	32	33
		 Not recommended		



7.6 Pressure tap piece

1. Mount the pressure tap piece at a point with unobstructed flow or steady measuring conditions.
2. The hole for the pressure tap piece must be sufficiently large; it is recommended to install a shut-off unit.

7.7 Measuring line

The measuring line connects the pressure tap piece and the pressure gauge.

- ▶ Select a measuring line with a sufficiently large inside diameter to help avoid clogging.
- ▶ Run the measuring line with a gradient. Provide a drain point at the lowest point in the case of gases and a vent point at the highest point in the case of highly viscous liquids.
- ▶ For gases and liquids containing solid particles, install a separator/filter which can be separated from the system by means of a shut-off unit during operation for emptying.
- ▶ Construct and install the measuring line in such a way that it can absorb all loads and stresses caused by expansion, vibration or heat influences.

7.8 Commissioning the product

Carefully commission the pressure measurement arrangement in order to avoid pressure surges or sudden temperature changes.

- ▶ Slowly open the shut-off units.

When subjecting pipe systems to pressure tests, never apply pressure to pressure gauges in excess of the specified permissible values for static loads for the pressure gauge. If necessary, shut off the pressure gauge or dismount it (see chapter 4.4, page 12).

In many cases, the range for static loads for a pressure gauge is indicated by a maximum value mark (as per EN 837-1, chapter 9.6.7/EN 837-3, chapter 9.6.6) on the dial. In the case of fluctuating loads, pressure gauges with maximum marks at the full scale end may only be subjected to a pressure of 0.9 times the full scale value. Pressure gauges with a maximum mark at 75 % of the full scale value or pressure gauges without a maximum mark may only be subjected to a pressure of 2/3 of the full scale value in the case of fluctuating loads.

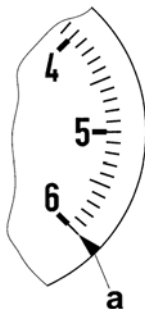

a Maximum value mark

Fig. 8: Maximum value mark

- ▶ When cleaning or flushing the pressure line, you must not exceed the maximum permissible operating temperature of the pressure gauge. If necessary, shut off the pressure gauge or dismount it (see chapter 8.1, page 32).

Bourdon tube pressure gauges NS50 with inductive contact: Adjusting the switching point

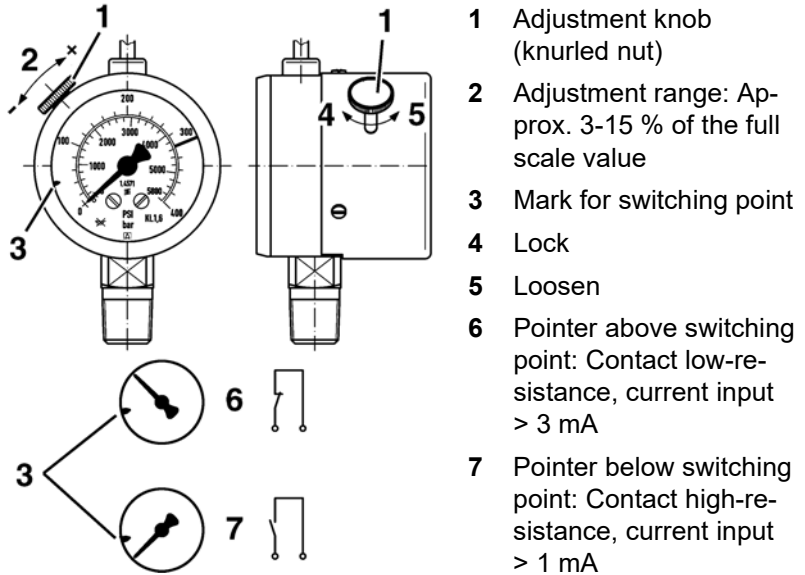

Fig. 9: Switching point

The switching point is factory-adjusted to the centre. The switching point can be adjusted manually.

1. Turn the adjustment knob counter-clockwise by approx. $\frac{1}{2}$ to 1 turn.
2. Move the adjustment knob in the slot at the housing.
- ↙ The switching point is adjusted within the given range.
- ↙ The red pointer tip at the outer diameter of the scale indicates the selected switching point.
3. After having selected the desired switching point, hand-screw the adjustment knob clockwise to lock it.



8 Operation

1. Slightly tap on the housing of the pressure gauge.
2. Read the pressure.
The error limits as per EN 837-1/-3 apply.
3. When cleaning or flushing the pressure line, you must not exceed the maximum permissible operating temperature of the pressure gauge. If necessary, shut off the pressure gauge or dismount it (see chapter 8.1, page 32).
4. In order to check the zero point of the pressure gauge during operation, close the required shut-off unit (see chapter 9.1, page 33) so no pressure is applied to the pressure gauge.
☞ The pointer must be in the tolerance range indicated by a bar at the zero point.
5. In order to check the indication of the pressure gauge during operation, disconnect it from the process by means of the required shut-off unit with test connection (see chapter 9.1, page 33) and apply test pressure.

8.1 Dismounting the pressure gauge

CAUTION

Hazard to persons, equipment and the environment due to escaping residue of the fluid

- Take appropriate protective measures against escaping residue of the fluid prior to disconnecting the pressure gauge.

-
1. Unpressurise the measuring element.
 2. Unpressurise the measuring line, if necessary.
 3. Dismount the pressure gauge.

9 Additional equipment

9.1 Shut-off unit

A shut-off unit between the pressure tap point and the pressure gauge allows you to check the zero point of the pressure gauge or to dismount the pressure gauge without interrupting the process. Depending on the application, you can use valves or cocks.

CAUTION**Injury due to escaping fluid**

- ▶ Arrange the vent opening into the atmosphere in such a way as to prevent persons from being injured by escaping fluid.

Cocks have three settings:

- Vent: The supply line is closed and the measuring device is connected to atmospheric pressure. The zero point can be checked.
- Operation: The supply line is open and process pressure is applied to the measuring device.
- Blow out: The supply line is open, the fluid is discharged into the atmosphere. The measuring device is out of operation.

Valves (for example, as per DIN 16270/16271) usually feature a bleed screw between the valve seat and the pressure gauge.

In certain applications (for example, steam boilers), the shut-off units must have a test connection so that the pressure gauge can be checked without having to be dismantled.

9.2 Pressure gauge holder

- ▶ If the measuring line is not sufficiently stable to carry the pressure gauge without transmitting vibrations or shocks, install a pressure gauge holder.



9.3 Siphons

If the temperature of the measured fluid at the measuring point is higher than the permissible operating temperature of the pressure gauge, the shut-off units and the pressure gauges must be protected from the hot fluid by means of sufficiently long measuring lines or siphons. Siphons (see current AFRISO catalogue or www.afriso.com) help to condense the fluid for the elastic measuring element and help to protect the pressure gauge from excessive temperatures of the measured fluid.

1. Mount a siphon filled with the fluid or a similar device close to the pressure gauge and fill it with the condensate of the fluid.
 2. Pressurise the arrangement.
- ↳ The hot measured fluid cannot reach the measuring device when pressure is applied.

9.4 Chemical seals

If the fluid is corrosive, hot, highly viscous or crystallising, chemical seals may be used to help prevent the fluid from reaching the pressure gauge. A neutral liquid is used to transmit the pressure to the measuring element.

1. Select this pressure transmission liquid according to the measuring range, temperature, viscosity, compatibility of the liquid and the fluid to be measured and other factors.
2. The installation of a cooling element between chemical seal and pressure gauge is advised so that the pressure transfer liquid can withstand the temperature of the fluid.
3. Do not separate the connection between chemical seal and pressure gauge.

Diaphragm pressure gauges offer an alternative to Bourdon tube pressure gauges with chemical seals. The accuracy class information shown on the dial applies to an ambient temperature of +20 °C. According to EN 837-1 a deviation resulting from temperature influences of up to 0.08 %/K of the full scale value is permissible for diaphragm pressure gauges.

9.5 Overpressure safety devices

- ▶ If, for operational reasons, the range must be smaller than the maximum operating pressure, install an upstream overpressure safety device to help protect the pressure gauge from damage.

Highly viscous or polluted media may have an adverse effect on the operation of the overpressure safety device or can render it ineffective.

In the case of a pressure surge, the overpressure safety device closes immediately, in the case of a slow pressure increase, it closes gradually. Therefore, the closing pressure to be set depends on the values along the progression.

9.6 Pressure gauge with maximum pointer

Since Bourdon tubes have a relatively small resetting force, you must account for their influence when installing a maximum pointer. Maximum indicators may only be used with pressure gauge types D4 and D8 at a minimum range of 6 bar.

9.7 Electrical contacts

Electrical contacts in pressure gauges are auxiliary electrical switches which open or close electrical circuits at set limit values by means of a contact arm which is moved in accordance with the indicated value.

- ▶ See DIN 16085 for information on switching functions, requirements, marks, test and acceptance of electrical contacts.

If you use pressure gauges with electrical contacts to help protect against exceeding permissible limit values, these contacts are classified as equipment with safety function (safety accessories) according to the Pressure Equipment Directive (2014/68/EU). As per annex II of the Pressure Equipment Directive, CE approval is required in accordance with the modules of category IV of the directive.

Sliding contact

A sliding contact is the contact of an auxiliary switch as per EN 60947-5-1 (IEC 947-5-1). The contact is activated by the movement of the gauge pointer. The movement depends on the pressure change.

The speed at which the contact pins come closer to each other only depends on the time the gauge pointer needs to move. The units switch when the gauge pointer and the setting pointer are congruent. Sliding contacts are suitable for applications which do not require high switching power and which are not subject to vibrations. Sliding contacts should not be used under the following conditions: high switching frequency, corrosive environments, devices with liquid filling, hazardous areas (EX areas).

Information on the nominal operating voltage, the nominal current, the switch rating and the switching function are shown on the dial or the nameplate.

Standards: EN 60947-1, EN 60947-1A11, EN 60947-5-1.



Magnetic spring contact

The design of magnetic snap action contacts is similar to that of sliding contacts. This type of contact features additional magnets to accelerate the contact action.

To close the circuit, the contact pin of the moving contact arm is attracted by the magnet so that the contact snaps closed. When the circuit opens, the magnet attracts the contact arm until the resetting force of the measuring element overcomes the effective force of the magnet so that the contact snaps open.

The snap action reduces arcing between the contacts, thus allowing for greater switch ratings. Due to the increased contact force, this type of contact is also less sensitive to vibrations and achieves a high switching reliability.

Magnetic spring contacts can be used under almost any type of operating condition. They can also be integrated into liquid filled pressure gauges. In order to help prevent switching errors (particularly in the case of greater inductive switch ratings or considerable system vibration or in gauges with filling), it is recommended to install the pulse-controlled series MSR contact protection relays.

Information on the nominal operating voltage, the nominal current, the switch rating and the switching function are shown on the dial or the nameplate.

Standards: EN 60947-1, EN 60947-1A11, EN 60947-5-1.

Inductive contact

Inductive contacts have non-contacting electric displacement pickups as per DIN 19234.

Inductive contacts are used together with an isolating switching amplifier. The switching amplifier supplies the control head with direct voltage. As soon as the control flag reaches the control head, the internal resistance in the control head increases. This causes the current to change which is used to control the switching amplifier. The amplifier converts the input signal into a binary output signal.

Due to non-contact switching, the high switching accuracy and the long service life, inductive contacts are suitable for industrial applications and should be used in liquid filled pressure gauges.

If suitable isolating switching amplifiers (such as WE77/Ex) are used, the system will have the type of protection intrinsic safety "i". It is classified as EEx ib IIC T6 and approved for use in hazardous areas, zones 1 and 2. Stainless steel pressure gauges for chemical applications are approved for use in hazardous areas, zones 1 and 2.

The isolation switching amplifier must always be installed outside of the hazardous area.

**Electronic contact**

The electronic contact with PNP switching output is particularly suitable for direct connection to a PLC. Due to the low voltages and currents, additional switching amplifiers are not required.

Reed contact

Pressure gauges with Reed contact have a bi-stable Reed sensor as their switching element. The Reed sensor is enclosed in a hermetically sealed glass tube. The glass tube is covered by a plastic envelope which helps to protect the Reed sensor from damage. The Reed sensor is a switch which is operated by a magnetic field. The magnetic field is generated by a permanent magnet which is attached to the pointer of the pressure gauge.

Pressure gauges with reed contacts are especially suitable for switching low voltages in the millivolt or microampere range. However, they can also be used for higher switching currents. With voltages < 5 volts the Reed contact is not subject to mechanical wear.

The switching characteristics of Reed contacts are determined by a hysteresis which depends on design-specific influences. The hysteresis renders the contact insensitive to vibrations and shock and helps to avoid incorrect switching. In order to obtain high switching accuracy, this hysteresis needs to be taken into consideration. The following switching functions are available:

- Switching on rising pressure (clockwise pointer movement), normally open contact or normally closed contact
- Switching on falling pressure (counter-clockwise pointer movement), normally open contact or normally closed contact

Pressure gauges with Reed contact are available with fixed or adjustable switching point.



10 Type code – design numbers

Digit 1 after the "D" for Design defines the housing version, digit 2 specifies the mounting type and digit 3 represents the measuring system (for example, D101).

Table 11: Housing versions

Digit 1	Housing	Window
D0	Hot-pressed brass with screw type bezel	Glass
D1	Plastic	Clip-in plastic
D2	Sheet steel, black	Clip-in plastic
D3	Stainless steel 1.4301	Clip-in plastic
D4	Stainless steel 1.4301 with bayonet bezel	Glass
D5	Stainless steel 1.4301 US version	Glass
D6	Plastic with crimped bezel, with glycerine filling	Plastic
D7	Stainless steel 1.4301 with crimped bezel, with glycerine filling	Plastic or glass
D8	Stainless steel 1.4301 with bayonet bezel, with glycerine filling	Glass
D9	Stainless steel 1.4301 with crimped bezel	Plastic or glass

Table 12: Mounting types

Digit 2	Mounting type
0	Bottom connection, direct
1	Centre back connection, direct
2	Centre back connection, 3-hole fixing, panel mounting bezel black
3	Centre back connection, 3-hole fixing, panel mounting bezel, chrome-plated or stainless steel 1.4301
4	Centre back connection, panel mounting bezel black with clamp fixing
5	centre back connection, panel mounting bezel chrome-plated or stainless steel 1.4301 with clamp fixing
7	Bottom connection, back flange, stainless steel 1.4301

Table 13: Measuring systems

Digit 3	Measuring system (wetted part)	
	Bourdon tube/capsule/diaphragm pressure gauge	Spring diaphragm pressure gauge
1	Copper alloy	Anodised aluminium, nickel-plated brass, stainless steel 301, Viton
2	Stainless steel	Stainless steel 316Ti/316L, stainless steel 301, Viton
3	Monel	-

11 Maintenance

Repairs may only be performed by the manufacturer, see chapter 13, page 41.

Table 14: Maintenance times

When	Activity
At regular intervals	► Verify the accuracy of the device by trained personnel using suitable equipment.
Pressure gauge shows signs of damage	► Immediately dismantle the pressure gauge, check it, and, if necessary, recalibrate it.



12 Decommissioning, disposal

1. Liquid filled pressure gauges: Remove the plug at the edge of the housing and completely empty the pressure gauge (drip-free).

Usually, Bourdon tube pressure gauges and capsule pressure gauges are glycerine-filled (99.5 %), the spring diaphragm pressure gauges are filled with a glycerine/water mixture (66 %). Pressure gauges with glycerine filling do not have special marks. If other liquids are used, a corresponding note providing information on the filling liquid is attached to the pressure gauge.

Table 15: Filling liquids for liquid filled pressure gauges

Filling liquid	European Waste Catalogue (EWC) code no.
Glycerine (99.5 %)	13 02 08
Glycerine/water (86,5%/66 %)	13 02 08
Silicone oil	13 02 08
Paraffin oil	13 02 08
Glissofluid A9	13 02 08



2. To protect the environment, filling liquid must **neither** be disposed of together with the normal household waste **nor** get into waters or the public drain system. Observe all applicable regulations when disposing of it. Have authorised specialised companies collect and dispose of the filling liquid.
3. Dismount the product (see chapter 7, page 21, reverse sequence of steps).
4. To protect the environment, this product must **not** be disposed of together with the normal household waste. Dispose of the product according to local directives and guidelines.



This product consists of materials that can be reused by recycling firms. The electronic inserts can be easily separated and the device consists of recyclable materials.

If you do not have the opportunity to dispose of the used device in accordance with environmental regulations, please contact us for possibilities to return it (see chapter 12, page 40).



13 Returning the device

In order to protect the environment and our staff, we will transport, check, repair or dispose of returned products only if this is possible without risk to health and environment.

- ▶ Always enclose a declaration of decontamination when returning a device (confirmation that the device is free from hazards)
- ▶ The declaration of decontamination can be downloaded at www.afriso.com.

Without a declaration of decontamination, we are unable to process your returned device. Thank you for your understanding.

If the product was operated with hazardous substances:

1. Decontaminate the device in accordance with all pertinent directives.
-  The product is free from hazardous substances.
2. Enclose proof of decontamination in accordance with all pertinent directives when returning the device.

14 Spare parts and accessories

Part	Part no.
Profile seal for inner centering for threads G $\frac{1}{4}$ and M 12 x 1,5; material: copper	39205
Profile seal for inner centering for threads G $\frac{1}{2}$ and M 20 x 1.5; material: copper	39206

15 Warranty

The manufacturer's warranty for this product is 24 months after the date of purchase. This warranty shall be good in all countries in which this product is sold by the manufacturer or its authorised dealers.

16 Copyright

The manufacturer retains the copyright to these operating instructions. These operating instructions may not be reprinted, translated, copied in part or in whole without prior written consent.

We reserve the right to technical modifications with reference to the specifications and illustrations in this manual.



17 Customer satisfaction

Customer satisfaction is our prime objective. Please get in touch with us if you have any questions, suggestions or problems concerning your product.

18 Addresses

The addresses of our worldwide representations and offices can be found on the Internet at www.afriso.com.



19 Appendix

19.1 EU Declaration of Conformity



Technik für Umweltschutz

Messen. Regeln. Überwachen.

EU - Konformitätserklärung

EU Declaration of Conformity / Déclaration EU de conformité /
Declaración de conformidad CE / Declaração de conformidade CE /
Deklaracja zgodności UE



Formblatt
FB 27 - 03

Name und Anschrift des Herstellers: AFRISO-EURO-INDEX GmbH, Lindenstraße 20, 74363 Güglingen
Manufacturer / Fabricant / Fabricante / Nome e endereço do fabricante / Producent:

Erzeugnis: Druckmessgerät
Product / Produit / Producto / Produto / Produkt:

Typenbezeichnung: RFxxx-Dxxx, KPxxx-Dxxx, PFxxx-Dxxx, MFxxx-Dxxx, RFxx; HZxx; HYxx
Type / Type / Tipo / Tipo / Typ:

Betriebsdaten: Anzeigebereiche 0,5 bar bis 4000 bar
Techn. Details / Caractéristiques / Características / Detalhes técnicos / Dane techniczne:

Wir erklären in alleiniger Verantwortung, dass das bezeichnete Erzeugnis mit den Vorschriften folgender Europäischer Richtlinien übereinstimmt:

We declare under our sole responsibility that the above mentioned product meets the requirements of the following European Directives:

Le produit mentionné est conforme aux prescriptions des Directives Européennes suivantes:

El producto indicado cumple con las prescripciones de las Directivas Europeas siguientes:

O produto indicado cumpre com as prescrições das seguintes Diretivas Europeias:

Wymieniony wyżej produkt spełnia wymagania następujących Dyrektyw Europejskich:

Druckgeräterichtlinie (2014/68/EU)

Pressure Equipment Directive / Directive équipements sous pression / Directiva equipos a presión /
Dyrektywa ciśnieniowa

Anzeigebereiche < 200bar: GIP nach Artikel 4.3 DGRL (keine CE-Kennzeichnung)

Anzeigebereiche ≥ 200bar nach Anhang I DGRL, Konformitätsbewertungsverfahren Modul A

Anschlussformen ≥ DN25 nach Anhang I DGRL, Konformitätsbewertungsverfahren Modul A

Normen-Übereinstimmung:

DIN EN 837-1: 02/1997 (Typenbezeichnung: RFxxx-Dxxx, von 0,5 bar bis 1600 bar)

DIN EN 837-3: 08/2019 (Typenbezeichnungen: KPxxx-Dxxx, PFxxx-Dxxx)

Unterzeichner:
Signed / Signataire / Firmante /
Assinado por / Podpisal:

Dr. Spath, Geschäftsführer Technik
Technical Director / Diretor Técnico / Dyrektor Techniczny

26. August 2024

Datum / Date / Fecha / Data

Jana Spath
Unterschrift / Signature / Firma / Assinatura / Podpis

Version: 3 Index: 5

AFRISO-EURO-INDEX GmbH D-74363 Güglingen

Seite 1 von 1



19.2 Information on the Pressure Equipment Directive

Informationen zur Druckgeräte-Richtlinie 2014/68/EU (DGRL), Pressure Equipment Directive (PED)

Die europäische Druckgeräte-Richtlinie ist am 30.5.2002 in Kraft getreten. Was sich dahinter verbirgt und welche Vorbereitungen unsererseits getroffen wurden, haben wir für Sie zusammengefasst:

Manometer der AFRISO-EURO-INDEX GMBH mit einem Messbereichsendwert größer 0,5 bar unterliegen als „Druckhaltende Ausrüstungsteile“ der DGRL und erfüllen deren Forderungen.

Da die künftigen Einsatzbedingungen der meisten Manometer in der Regel nicht vollständig bekannt sind fertigen wir grundsätzlich nach den schärfsten Kriterien (Gase der Gruppe 1).

Dadurch erhalten unsere Manometer ab einem Messbereichsendwert von 200 bar entsprechend dem Konformitätsbewertungsverfahren eine CE-Kennzeichnung.

Manometer mit einem Anschlussflansch größer DN25 erhalten bereits ab einem Messbereichsendwert von 0,5 bar eine CE-Kennzeichnung.

Die CE-Kennzeichnung erfolgt mittels Typenschild außen am Gehäuse.

Eine Konformitätserklärung wird auf Wunsch mitgeliefert.

Eine detaillierte Betriebsanleitung und entsprechende Datenblätter sind unter www.afriso.de ersichtlich und können auf Wunsch mitgeliefert werden.

Manometer mit einem Messbereichsendwert kleiner 0,5 bar bzw lose Druckmittler fallen nicht unter die DGRL und dürfen keine CE-Kennzeichnung tragen.

Manometer mit einem Messbereichsendwert zwischen 0,5 bar und 200 bar fallen unter „Gute Ingenieurpraxis“ (Artikel 4 Absatz 3) und dürfen keine CE-Kennzeichnung tragen.

Manometer ohne Firmennamen bzw. Firmenlogo dürfen von uns nicht mit einer CE-Kennzeichnung versehen werden.

Für Manometer, die Teil einer Sicherheitseinrichtung zum Schutz gegen Überschreitung zulässiger Grenzen sind („Ausrüstungsteile mit Sicherheitsfunktion“), ist eine gesonderte Betrachtung vorzunehmen.

Unsere Manometer entsprechen der Europäischen Norm EN 837 und werden nach deren Forderungen gefertigt und geprüft.